

# User Manual

# APPC-15XP R23



**PRO DVX** | ALWAYS

**ProDVX Europe B.V.**  
Europalaan 10  
5232 BC, Den Bosch  
The Netherlands

+31(0)73 737 0345  
sales@prodvx.com

# Table of Contents

- 1. Unpacking**..... 3
- 2. Physical view and features**..... 4
  - 2.1 Front view APPC-15XP R23** ..... 4
  - 2.3 I/O ports and buttons APPC-15XP R23 back & bottom** ..... 5
  - 2.4 APPC-15XP R23 adapter (optional)**..... 7
- 3. Powering on the product**..... 8
- 4. Product functionality** ..... 10
- 5. Support and cleaning** ..... 12
  - 5.1 Support** ..... 12
  - 5.2 Cleaning**..... 12
- 6. Technical specifications**..... 14
- 7. Pixel defect policy** ..... 15
  - 7.1 Pixels and sub-pixels** ..... 15
  - 7.2 Types of pixel defects + dot definition** ..... 15
  - 7.3 Bright dot defects**..... 16
  - 7.4 Dark dot defects** ..... 16
  - 7.5 Pixel defect tolerances**..... 16
  - 7.6 Mura**..... 17
- 8. Warranty**..... 18
- 9. Safety instructions**..... 19
- 10. Declaration and statements** ..... 22
  - 10.2 FCC Declaration of Conformity (U.S. only)** ..... 22
  - 10.3 Waste Electrical and Electronic Equipment-WEEE**..... 23
  - 10.4 Software end user license agreement** ..... 24

# 1. Unpacking

## 1.1 General instructions

This electronic user guide is intended for all ProDVX product users. Take time to read it before you use your product. It contains important information and notes regarding the use of your product. The ProDVX guarantee applies provided the product is handled properly for its intended use, in accordance with its operating instructions and upon presentation of the original invoice or cash receipt, indicating the date of purchase, dealers name and model and the product production number. Please read and follow the safety precautions and maintenance instructions starting on page 20 when connecting and using your display.

## 1.2 Package content

Verify that the box contains:

- ProDVX APPC-15XP R23 device
- Quick Start Guide

Preliminary steps:

- Please remove all protective materials from the device.
- Inspect the device for damage.

Contact ProDVX if there is damage or something is missing.

# 2. Physical view and features

## 2.1 Front view APPC-15XP R23

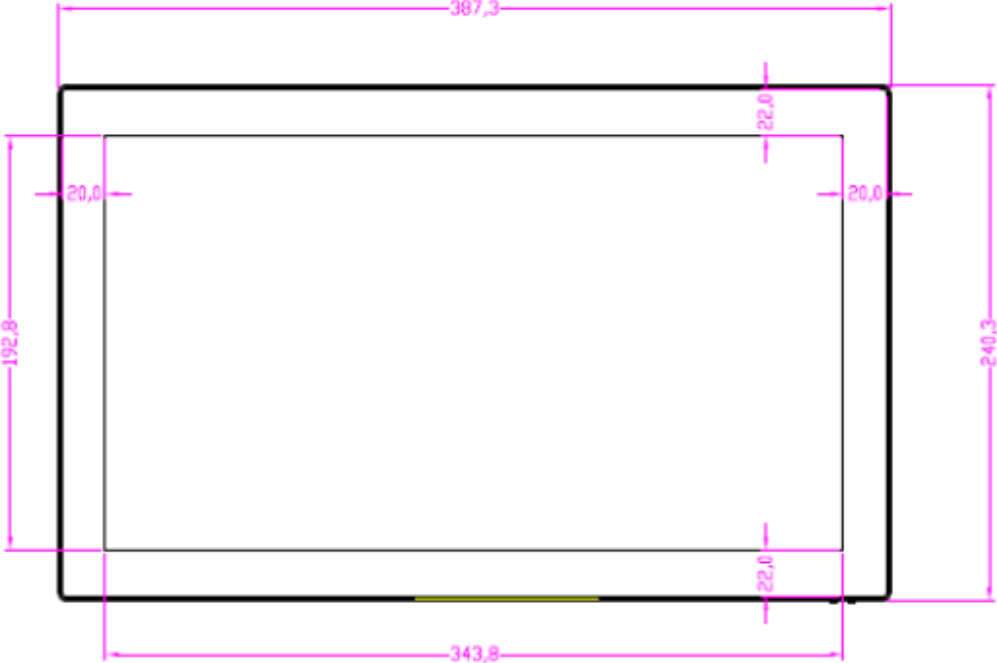

## 2.2 Rear view APPC-15XP R23

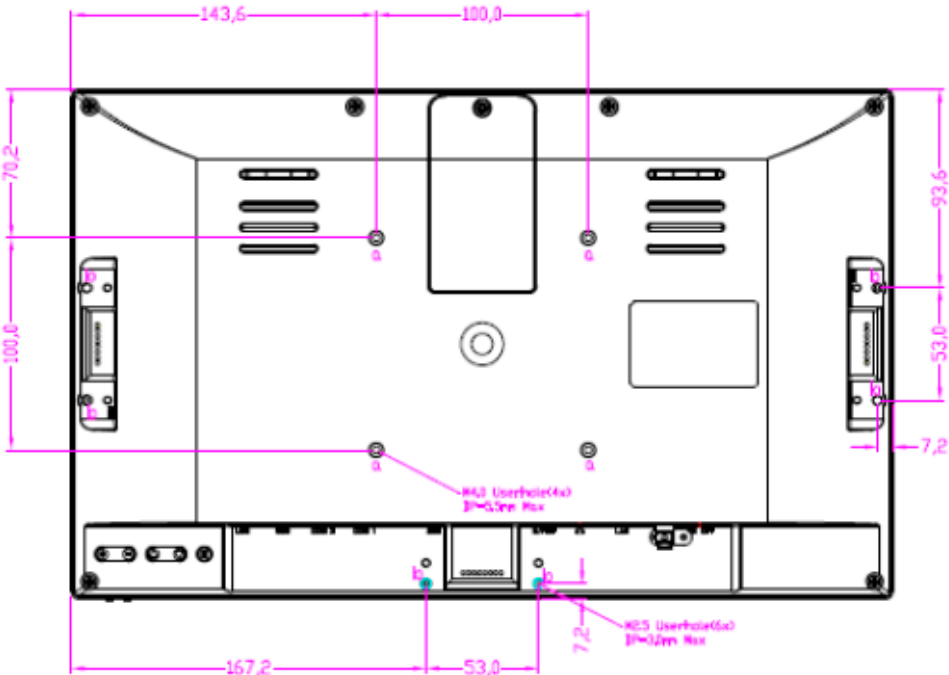

## 2.3 I/O ports and buttons APCC-15XP R23 back & bottom

### Back:

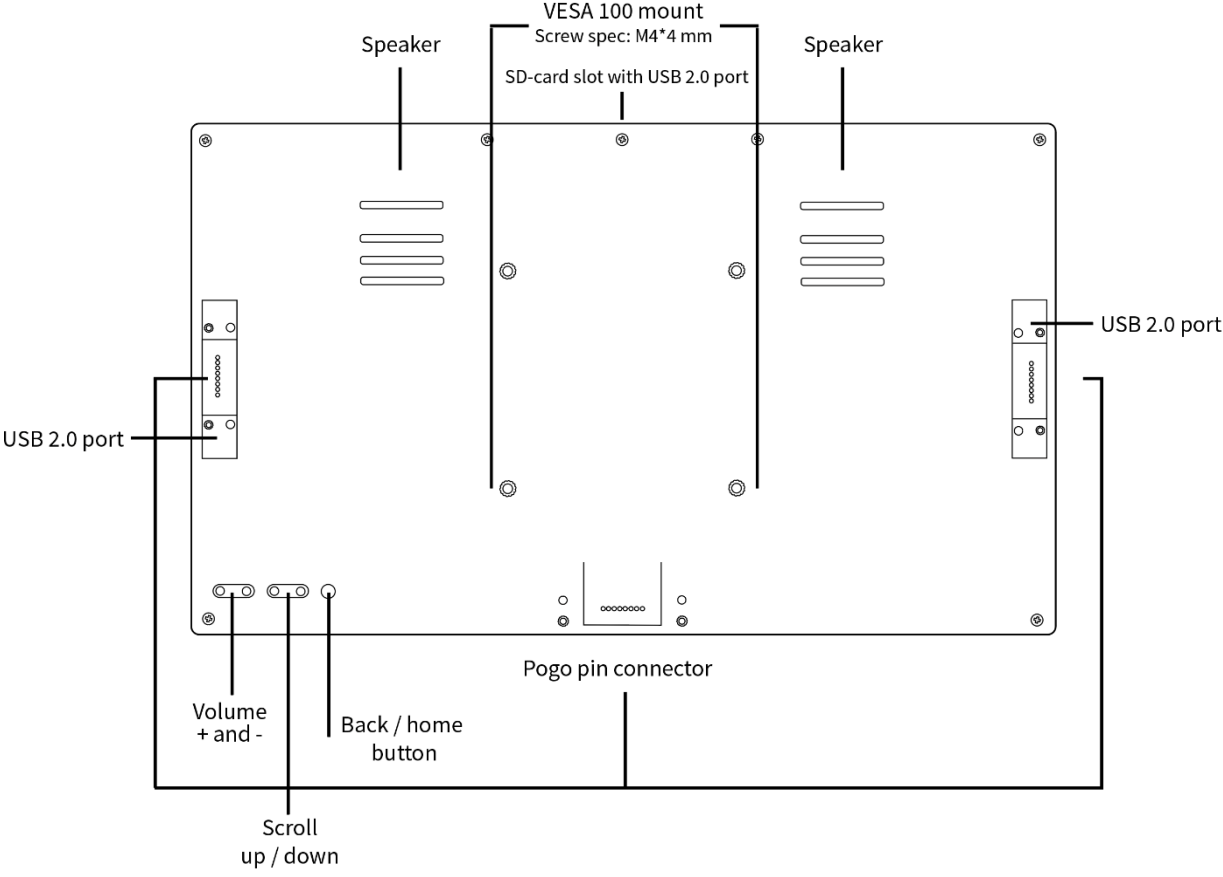

**Bottom:**

- On / off switch
- 12 V DC-in
- LAN port
- Audio port 3.5 mm
- S/PDIF port
- GPIO port
- USB-C port
- Mini HDMI out
- COM port 2
- COM port 1
- USB 3.0 port
- USB 2.0 port

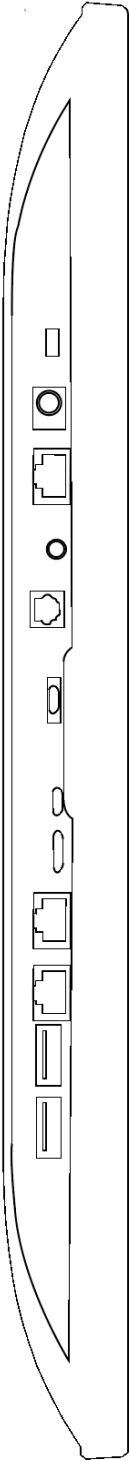

**2.4 APPC-15XP R23 adapter (optional)**

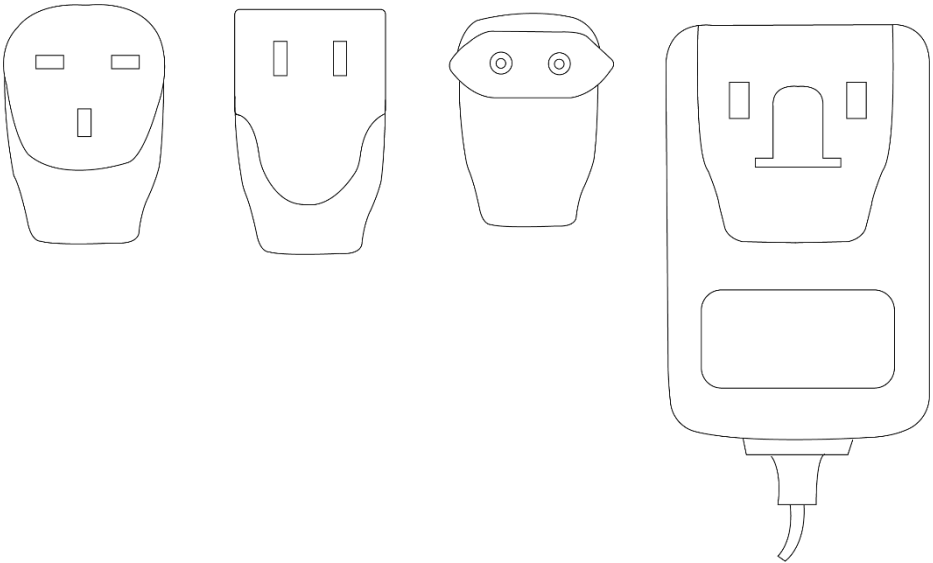

# 3. Powering on the product

Step 1: Plug in PoE+ cable or power adapter to turn on display. If using PoE+ for both power and data, continue to step 5. If connection to Wi-Fi is preferred, swipe up when you get to the home menu to arrive in the app drawer. Once there, select Settings.

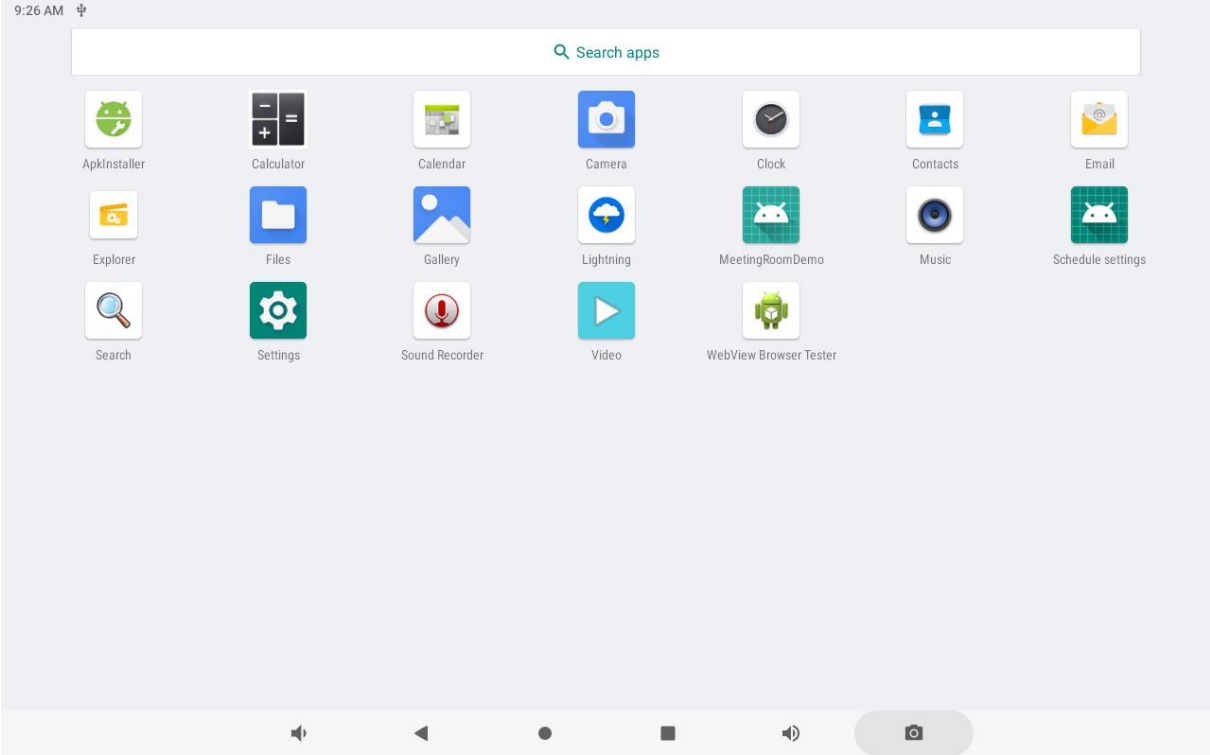

Step 2: In the settings menu, go to Network & internet, located at the top of the menu.

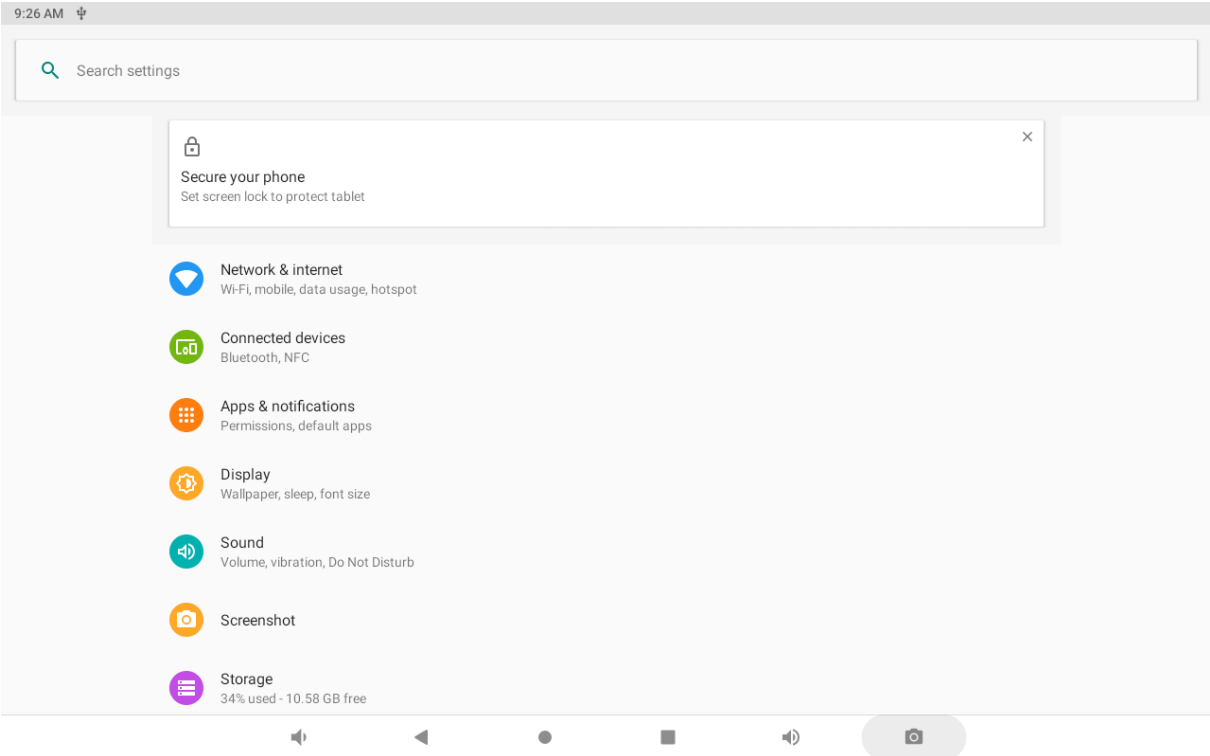



Step 3: In the Network & internet menu, select Wi-Fi.

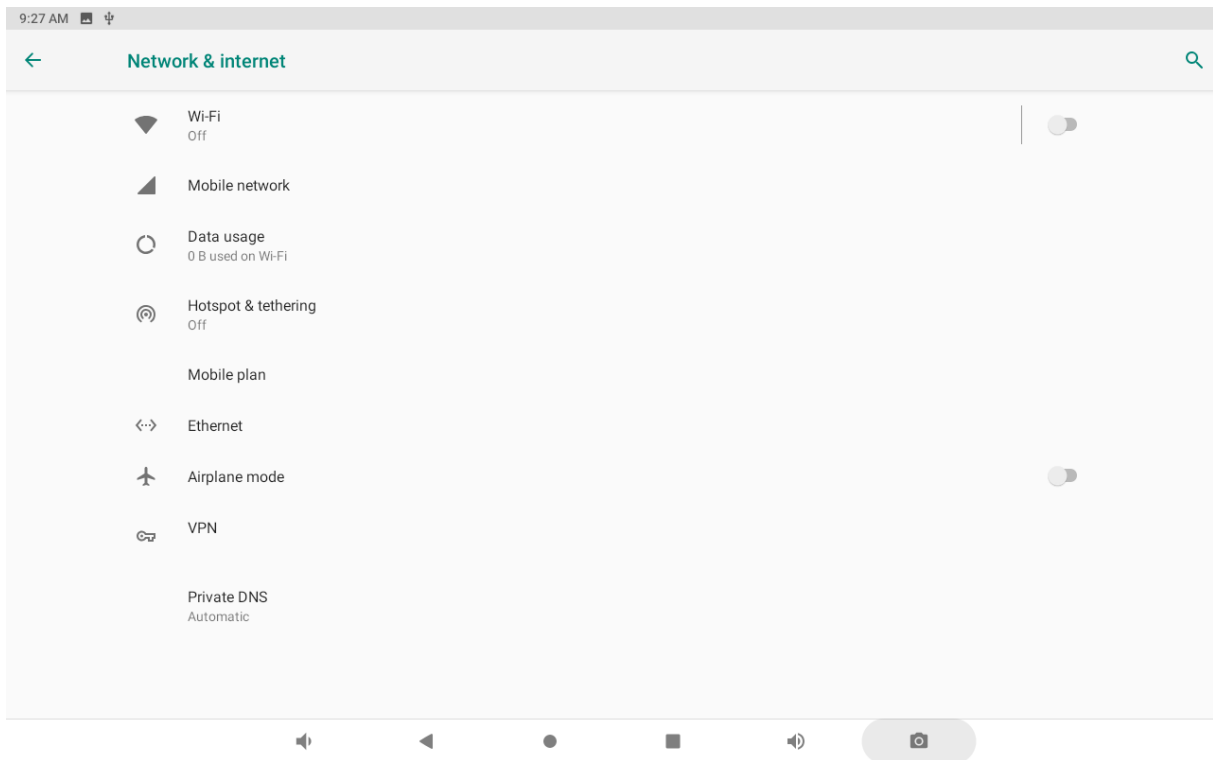

Step 4: Turn on Wi-Fi and select desired Wi-Fi network to connect to internet.

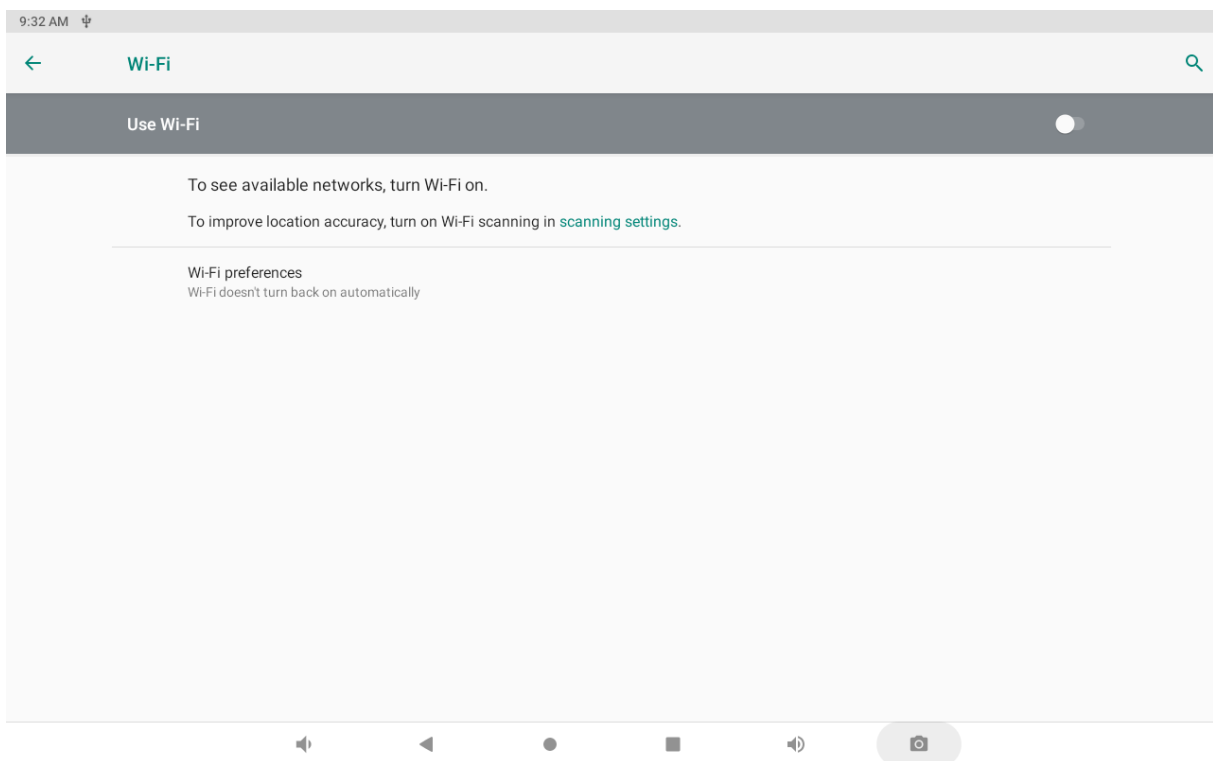

Step 5: Install and configure the applications of your choice.

## 4. Product functionality

The APPC-15XP R23 is fitted with several connectivity options and buttons.

### Power supply port

The APPC-15XP R23 can be connected to a 12 V DC-in power supply through the port at the bottom of the device.

### VESA mount holes

This device is fitted with a 100x100 mm VESA pattern. Please mount the device according to the documentation provided with the mount. Take extra care with the screws: please use screws with a length of 4 mm, up to 6 mm (minus the thickness of the mount). Longer screws might damage the device internals. Please do not over-tighten the screws as this will damage the device internals.

### Pogo pin connector (USB 2.0)

The device is fitted with 3 Pogo pin connectors located on the bottom and left and right sides of the device, to which our 1D/2D bar code scanner, NFC module, Camera module or LED module can be securely connected.

### Function keys

The device has a set of function keys on the topside of the back of the display. The function keys consist of a volume button, a button to scroll up or down, a button to go back/to the home screen and a switch which lets you turn the device on or off.

### LAN port / Wi-Fi / Bluetooth

The device has a 10/100/1000 Mbps LAN (RJ45) connection. The APPC-15XP R23 can also be powered through Power over Ethernet+.

Next to the Ethernet port, the device has an embedded wireless LAN module (802.11 a/b/g/n/ac) that supports Bluetooth 4.2

### Audio port (3.5mm)

This port can be used to connect a headphone, including a microphone. Please note that when plugged in, the internal speakers are disabled.

## **USB-C port**

The APPC-15XP R23 features a type C USB port on the bottom side of the device for data transfer and connection to peripherals such as USB storage devices, webcams, etc.

## **USB 3.0 port**

The APPC-15XP R23 features a USB-3.0 port on the bottom side of the device for data transfer and connection to peripherals such as USB storage devices, webcams, etc.

## **USB-2.0 port**

The APPC-15XP R23 features 4 type A USB-2.0 ports, which are located on the bottom, left, and right sides and under the SD card slot of the device. These ports can be used for data transfer and connection to peripherals such as USB storage devices, webcams, etc.

## **HDMI-out port**

The device has a mini HDMI connector for connecting an external display to the device. Please note this is an HDMI-out port only.

## **S/PDIF port**

Located at the bottom side of the device is a S/PDIF port for outputting audio signals over shorter distances.

## **RS232 port**

The APPC-15XP R23 features 2 RS232 ports on the bottom of the device that serve as COM ports. They come in RJ45 form.

## **GPIO port**

The device features a GPIO port on the bottom of the unit which can be used for various purposes and performs both input and output functions.

## **SD card slot**

On the back side of the device is an SD card slot that also contains an USB-2.0 port.

## 5. Support and cleaning

### 5.1 Support

Symptom	Possible cause	Possible remedy
I have no connection	1. Is a network cable inserted?	1. Insert the cable. Make sure to insert it into the correct connector.
	2. Is the device connected to a Wi-Fi network?	2. Connect the device to a Wi-Fi network.
	3. Are the drivers installed?	3. If not, contact ProDVX support.
I have no sound	1. Is the sound level correct?	1. Use the volume buttons to adjust the level.
	2. Are the headphones connected?	2. Disconnect the headphones to enable the internal speakers.
	3. Are the drivers installed?	3. If not, contact ProDVX support.
I have no display	1. Is the device switched off?	1. Press the small power switch on the device.
	2. Is the PSU connected?	2. Connect the PSU.
My USB stick isn't recognized	1. Is the USB stick properly formatted?	1. Format the USB stick in NTFS file format.
	2. Is the USB stick properly inserted?	2. Disconnect the USB stick and reconnect it to the USB port.
My display is not correct	1. Has the resolution been altered?	1. Increase or decrease the resolution setting.

### 5.2 Cleaning

#### Caution When Using the Monitor

- Be sure to disconnect all cables before moving the monitor. Moving the monitor with the cables attached may damage the cables and cause fire or electrocution.
- Disconnect the power plug from the wall outlet as a safety precaution before performing any type of cleaning or maintenance procedure.

### **Front Panel Cleaning Instructions**

- The front of the display has been specially treated. Wipe the surface gently using only a cleaning cloth or a soft, lint-free cloth.
- If the surface becomes dirty, soak a soft, lint-free cloth in a mild detergent solution. Wring the cloth to remove excess liquid. Wipe the surface of the display to remove dirt. Then use a dry cloth of the same type to dry it.
- Do not scratch or hit the surface of the panel with fingers or hard objects of any kind.
- Do not use volatile substances such as insect sprays, solvents or thinners.

## 6. Technical specifications

Panel		System	
Size	15.6"	CPU	Dual Cortex A72, Quad Core, RK3399
Resolution	1920 x 1080	GPU	MALI T860MP4 / 3D Graphic Engine (4K)
Brightness	300 cd/m <sup>2</sup>	System Memory	4GB LPDDR4 SDRAM
Viewing Angle	H 170° / V 170°	Internal Storage	16GB eMMC
Touch Type	10 point touch projected capacitive	OS	Android 11
Contrast Ratio	800:1	Network LAN RJ45	10/100/1000 Mbps LAN
Aspect Ratio	16:9 wide	Power over Ethernet	IEEE 802.3at (PoE+)
		Wi-Fi	IEEE 802.11 a/b/g/n/ac
		Bluetooth	BT 4.2

Physical		Other	
Housing	Plastic	I/O Ports	4x USB-2.0, USB-3.0, USB-C, mini HDMI-out, 3.5 mm audio port, LAN port (RJ45), 2x RS232 (RJ45), 12 V DC-IN, S/PDIF, GPIO port
Color	Black	Camera	N/A
Weight	1300 g	Microphone	Yes
Dimensions	388 x 241 x 28 mm	Audio Jack output	Yes
Mounting / VESA	VESA 100	Speakers	2 x 3 W
Power Supply	12 V / 2 A (EU, UK, US)		
Power Usage	10 ~ 20 Watt		

## 7. Pixel defect policy

We make every effort to deliver the highest quality products and use some of the industry's most advanced manufacturing processes whilst practicing stringent quality control. However, pixel or sub-pixel defects on the panels used in LCD displays are sometimes unavoidable. No manufacturer can guarantee that all panels will be free of pixel defects, but ProDVX guarantees that any LCD display with an unacceptable number of defects will be repaired during the warranty period in line with your local guarantee conditions.

This notice explains the different types of pixel defects and defines the acceptable defect level for the LCD screen. In order to qualify for repair under warranty, the number of pixel defects must exceed a certain level as shown in the reference table. If the LCD screen is within specification, a warranty exchange/claim back will be refused. Additionally, given that certain types or combinations of pixel defects are more noticeable than others, ProDVX sets even higher quality standards for these.

### 7.1 Pixels and sub-pixels

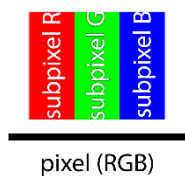

A pixel, or picture element, is composed of three sub-pixels in the primary colors red, green and blue. Many pixels together form an image. When all the sub-pixels of a pixel are lit, the three colored sub-pixels together appear as a single white pixel. When they are all dark, the three colored sub-pixels together appear as a single black pixel. Other combinations of lit and dark sub-pixels appear as single pixels of other colors.

### 7.2 Types of pixel defects + dot definition

Pixel and sub-pixel defects appear on the screen in different ways. There are three categories of pixel defects and several types of sub-pixel defects within each category.

Dot definition = what is a defective "dot"?:

One or more defective, adjacent sub-pixels are defined as one "dot". The number of defective sub-pixels is not relevant to define a defective dot. This means that a defective dot may consist of one, two or three defective sub-pixels which may be dark or lit.

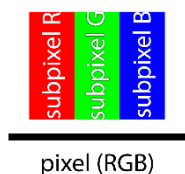

One dot = one pixel; consists of three red, green and blue sub-pixels.

### 7.3 Bright dot defects

Bright dot defects appear as pixels or sub-pixels that are always lit or “on”. These are the examples of bright dot defects:

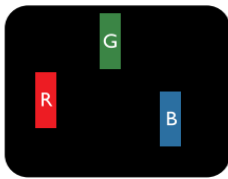

One lit red, green or blue sub pixel

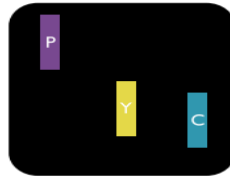

Two adjacent lit sub pixels:  
red + blue = purple  
red + green = yellow  
green + blue = cyan

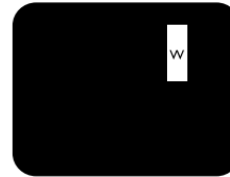

Three adjacent lit sub pixels  
(one white pixel)

### 7.4 Dark dot defects

Black dot defects appear as pixels or sub-pixels that are always dark or “off”. These are the examples of black dot defects:

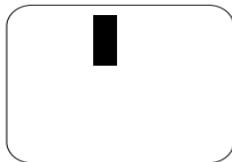

One dark dot



Two adjacent dark dots  
(1 pair of dark dots)

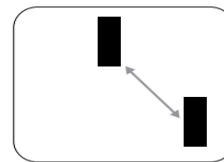

Two dark dots

### 7.5 Pixel defect tolerances

In order to qualify for repair due to pixel defects during the warranty period, an LCD display must have pixel or sub-pixel defects exceeding the tolerances listed in the following table.

Bright dot effect:	Acceptable level
1 lit sub pixel	1
Black dot effect:	Acceptable level
1 dark subpixel	3
Total dot defects* of all types:	1

NOTE: \* 1- 3 adjacent sub pixel defects = 1 dot defect



## 7.6 Mura

Dark spots or patches may occasionally appear on some liquid crystal display (LCD) panels. This is known in the industry as Mura, a Japanese term for “unevenness.” It is used to describe an irregular pattern or area in which uneven screen uniformity appears under certain conditions. Mura is a result of the deterioration of the liquid crystal alignment layer and is most commonly caused by long-term operation under high ambient temperatures. It is an industry- wide phenomenon and Mura is not repairable. It is also not covered by our warranty terms.

Mura has been around since the introduction of LCD technology and with screens getting bigger and in operation 24/7, many displays run in low light conditions. This all adds to the possibility of Mura affecting displays.

### **How to detect Mura**

There are many symptoms of Mura and also multiple causes. Several of these are listed below:

- Impurities or foreign particles in the crystal matrix
- Uneven distribution of LCD matrix during manufacturing
- Non-uniform luminance distribution of the backlight
- Panel assembly induced stress
- Flaws within the LCD cell
- Thermal induced stress - high temperature operation over long periods of time

### **How to avoid Mura**

Although we cannot guarantee the complete eradication of Mura every time, in general the appearance of Mura can be minimized by these methods:

- Lower the backlight brightness
- Use a screensaver
- Reduce the ambient temperature around the unit

## 8. Warranty

Please refer to our website <https://www.prodvx.com/support>, or scan the QR Code, for the updated warranty information and RMA procedures.



# 9. Safety instructions

## Safety precautions and maintenance

This electronic user guide is intended for all ProDVX product users. Take time to read it before you use your product. It contains important information and notes regarding the use of your product. The ProDVX guarantee applies provided the product is handled properly for its intended use, in accordance with its operating instructions and upon presentation of the original invoice or cash receipt, indicating the date of purchase, dealer's name, and model and product production number.



**WARNING:** Use of controls, adjustments or procedures other than those specified in this documentation may result in exposure to shock, electrical hazards and/or mechanical hazards.

## Read and follow these instructions when connecting and using your display:

### Operation

- Keep the display out of direct sunlight and away from stoves or any other heat sources.
- Remove any object that could fall into ventilation holes or prevent the proper cooling of the display's electronics.
- Do not block the ventilation holes on the cabinet.
- When positioning the display, make sure the power plug and outlet are easily accessible.
- When turning off the display by detaching the power cord or DC power cord, wait 6 seconds before re-attaching the power cord or DC power cord for normal operation.
- We strongly recommend you use a proper "shut-down" command instead of disconnecting the display from the power source, to prevent potential damage to the internal systems
- Ensure the use of an approved power cord provided by ProDVX at all times. If your power cord is missing, please contact your local service center.
- Do not expose the display to severe vibration or high impact conditions during operation.
- Do not knock or drop the display during operation or transportation.

### Maintenance

- To protect your display from possible damage, do not put excessive pressure on the LCD panel. When moving your display, grasp the frame to lift it; do not lift the display by placing your hand or fingers on the LCD panel.
- Unplug the display if you are not going to use it for a long period of time.
- Unplug the display if you need to clean it with a slightly damp cloth. The screen may be wiped with a dry cloth when the power is off. However, never use organic solvents such as alcohol, or ammonia-based liquids to clean your display.
- To avoid the risk of shock or permanent damage to the set, do not expose the display to dust, rain, water or an excessively moist environment.
- If your display becomes wet, wipe it with dry cloth as soon as possible.

- If a foreign substance or water enters your display, turn the power off immediately and disconnect the power cord. Then remove the foreign substance or water and send the unit to the maintenance center.
- Do not store or use the display in locations exposed to heat, direct sunlight or extreme cold.
- In order to maintain the best performance of your display and ensure a longer lifetime, we strongly recommend using the display in a location that has the following temperature and humidity ranges:
  - Temperature: 0-40°C 32-104°F
  - Humidity: 10-85% RH

**IMPORTANT:** Always activate a moving screen saver program when you leave your display unattended. Always activate a periodic screen refresh application if the unit displays unchanging static content. Uninterrupted display of still or static images over an extended period may cause “burn-in”, also known as “after-imaging” or “ghost imaging”, on your screen. This is a well-known phenomenon in LCD panel technology. In most cases, the “burned in”, “after-imaging” or “ghost imaging” will disappear gradually over a period of time once the power has been switched off.

**WARNING:** Severe “burn-in”, “after-image” or “ghost image” symptoms will not disappear and cannot be repaired. This is also not covered by the terms of your warranty.

### Service

- The casing cover should only be opened by qualified service personnel.
- If there is any need for repair or integration, please contact your local service center.
- Do not leave your display in direct sunlight.

If your display does not operate normally, even after following the instructions set out in this document, please contact a technician or your local service center.

### Read and follow these instructions when connecting and using your display:

- Unplug the display if you are not going to use it for a long period of time.
- Unplug the display if you need to clean it with a slightly damp cloth. The screen may be wiped with a dry cloth when the power is off. However, never use alcohol, solvents or ammonia-based liquids.
- Consult a service technician if the display does not operate normally when you have followed the instructions in this guide.
- The casing cover should only be opened by qualified service personnel.
- Keep the display out of direct sunlight and away from stoves or any other heat sources.
- Remove any object that could fall into the vents or prevent the proper cooling of the display’s electronics.
- Do not block the ventilation holes on the cabinet.
- Keep the display dry. To avoid electric shock, do not expose it to rain or excessive moisture.
- When turning off the display by detaching the power cable or DC power cord, wait for 6 seconds before reattaching the power cable or DC power cord for normal operation.
- To avoid the risk of shock or permanent damage to the set, do not expose the display to rain or excessive moisture.

- When positioning the display, make sure the power plug and outlet are easily accessible.
- **IMPORTANT:** Always activate a screen saver program during your application. If a still image in high contrast remains on the screen for an extended period of time, it may leave an 'after-image' or 'ghost image' on the front of the screen. This is a well-known phenomenon that is caused by the shortcomings inherent in LCD technology. In most cases, the afterimage will disappear gradually over a period of time once the power has been switched off. Bear in mind that the after-image symptom cannot be repaired and is not covered by the warranty.

# 10. Declaration and statements

## 10.1 EU Declaration of Conformity pixels and sub-pixels

 This product complies with the requirements set out in the Council Directive on the Approximation of the Laws of the Member States relating to Electromagnetic Compatibility (2014/30/EU), Low-voltage Directive (2014/35/EU), RoHS directive (2011/65/EU), and Radio Equipment Directive (2014/53/EU).

This product has been tested and found to comply with the harmonized standards for Information Technology Equipment. These harmonized standards are published under Directives of Official Journal of the European Union.

Radio Equipment Directive (2014/53/EU): EN 60950-1/EN 62311/EN 300328/EN 301489

### ESD Warnings

When the user is close to the monitor, this may cause the equipment to discharge and reboot to the display of main menu.

**WARNING:** This equipment is compliant with Class A of EN 55032/CISPR 32. In a residential environment, this equipment may cause radio interference.

## 10.2 FCC Declaration of Conformity (U.S. only)



NOTE: This equipment has been tested and found to comply with the limits for a Class A digital device, pursuant to part 15 of the FCC Rules. These limits are designed to provide reasonable protection against harmful interference when the equipment is operated in a commercial environment. This equipment generates, uses, and can radiate radio frequency energy and, if not installed and used in accordance with the user guide, may cause harmful interference to radio communications. Operation of this equipment in a residential area is likely to cause harmful interference in which case the user will be required to correct the interference at their own expense.

Changes or modifications not expressly approved by the party responsible for compliance could void the user's authority to operate the equipment.

Use only an RF shielded cable that is supplied with the display when connecting this display to a computer device. To prevent damage which may result in fire or shock hazard, do not expose this appliance to rain or excessive moisture.

### USA

**WARNING:** Changes or modifications to this unit not expressly approved by the party responsible for compliance could void the user's authority to operate the equipment.



This device complies with Part 15 of the FCC Rules. Operation is subject to the following two conditions: (1) This device must not cause harmful interference, and (2) this device must accept any interference received, including interference that may cause undesired operation.

Le présent appareil est conforme aux CNR d'ISED applicables aux appareils radio exempts de licence. L'exploitation est autorisée aux deux conditions suivantes : (1) le dispositif ne doit pas produire de brouillage préjudiciable, et (2) ce dispositif doit accepter tout brouillage reçu, y compris un brouillage susceptible de provoquer un fonctionnement indésirable.

### **Radiation Exposure Statement**

This equipment complies with FCC/CE-RED radiation exposure limits set forth for an uncontrolled environment. This equipment should be installed and operated with minimum distance 20cm between the radiator and your body.

Déclaration d'exposition aux radiations : Cet équipement est conforme aux limites d'exposition aux rayonnements ISED établies pour un environnement non contrôlé. Cet équipement doit être installé et utilisé avec un minimum de 20 cm de distance entre la source de rayonnement et votre corps.

The suitable temperature for the display and accessories is 0°C - 45°C. An adaptor with ferrite must be used with this equipment to ensure compliance with the Class A FCC limits.

Power Adapter information: INPUT: 100-240 V~50 / 60 Hz 0.6 A O OUTPUT: 12 V DC 5.0 A

## **10.3 Waste Electrical and Electronic Equipment-WEEE**



### **Warning for users in European Union private households**

This marking on the product or on its packaging illustrates that, under European Directive 2012/19/EU on waste electrical and electronic equipment, this product may not be disposed of with normal household waste. You are responsible for disposal of this equipment through a designated waste electrical and electronic equipment collection. To determine the locations for dropping off such waste electrical and electronic, contact your local government office, the waste disposal organization that serves your household or the store at which you purchased the product.

### **Warning for users in the United States**

Please dispose of according to all Local, State and Federal Laws. For the disposal or recycling information, contact: [www.mygreenelectronics.com](http://www.mygreenelectronics.com) or [www.eiae.org](http://www.eiae.org).



### **End of Life Directives / Recycling**

Your new Public Information Display contains several materials that can be recycled for

new users. Please dispose of according to all Local, State, and Federal laws.



**CAUTION:** RISK OF EXPLOSION IF BATTERY IS REPLACED BY AN INCORRECT TYPE. DISPOSE OF USED BATTERIES ACCORDING TO THE INSTRUCTIONS.

- Replacement of a battery with an incorrect type that can defeat a safeguard (for example, in the case of some lithium battery types).
- Disposal of a battery into fire or a hot oven, or mechanically crushing or cutting of a battery, that can result in an explosion.
- Leaving a battery in an extremely high temperature surrounding environment that can result in an explosion or the leakage of flammable liquid or gas.

A battery subjected to extremely low air pressure that may result in an explosion or the leakage of flammable liquid or gas.

## 10.4 Software end user license agreement

### NOTICE

#### SOFTWARE END USER LICENSE AGREEMENT

THIS SOFTWARE END USER LICENSE AGREEMENT (THIS “AGREEMENT”) IS A LEGAL AND BINDING AGREEMENT BETWEEN YOU (EITHER AN INDIVIDUAL OR ENTITY) PRODVX EUROPE B.V., A DUTCH LIMITED LIABILITY COMPANY, WITH ITS PRINCIPAL OFFICE AT EUROPALAAN 12F, 5232BC DEN BOSCH, THE NETHERLANDS AND ITS SUBSIDIARY COMPANIES (INDIVIDUALLY AND COLLECTIVELY “PRODVX”). THIS AGREEMENT GIVES YOU THE RIGHT TO USE CERTAIN SOFTWARE (THE “SOFTWARE”) INCLUDING USER DOCUMENTATION IN ELECTRONIC FORM WHICH MAY HAVE BEEN PROVIDED SEPARATELY OR TOGETHER WITH A PRODVX PRODUCT (THE “DEVICE”). BY DOWNLOADING, INSTALLING OR OTHERWISE USING THE SOFTWARE, YOU ACCEPT AND AGREE TO BE BOUND BY ALL OF THE TERMS AND CONDITIONS OF THIS AGREEMENT. IF YOU DO NOT AGREE TO THESE TERMS AND CONDITIONS, DO NOT DOWNLOAD, INSTALL OR OTHERWISE USE THE SOFTWARE. IF YOU ACQUIRED THE SOFTWARE IN TANGIBLE MEDIA E.G. CD WITHOUT THE OPPORTUNITY TO REVIEW THIS LICENSE AND DO NOT ACCEPT THESE TERMS, YOU MAY RECEIVE A FULL REFUND OF THE AMOUNT, IF ANY, THAT YOU PAID FOR THE SOFTWARE IF YOU RETURN THE SOFTWARE UNUSED WITH PROOF OF PAYMENT WITHIN 30 DAYS FROM THE DATE OF PURCHASE.

**1. Grant of License.** This Agreement grants you a non-exclusive, nontransferable, non-sub licensable license to install and use, on the Device, one (1) copy of the specified version of the Software in object code format as set out in the user documentation solely for your personal use. The Software is “in use” when it is loaded into the temporary or permanent memory (i.e. RAM, hard disk, etc.) of the Device.

**2. Ownership.** The Software is licensed and not sold to you. This Agreement grants you only the right to use the Software, but you do not acquire any rights, express or implied, in the Software other than those specified in this Agreement. ProDVX and its licensors retain all right, title, and



interest in and to the Software, including all patents, copyrights, trade secrets, and other intellectual property rights incorporated therein. The Software is protected by copyright laws, international treaty provisions, and other intellectual property laws. Therefore, other than as expressly set forth herein, you may not copy the Software without prior written authorization of ProDVX, except that you may make one (1) copy of the Software for your back-up purposes only. You may not copy any printed materials accompanying the Software, or print more than one (1) copy of any user documentation provided in electronic form, except that you may make one (1) copy of such printed materials for your back-up purposes only.

**3. License Restrictions.** Except as provided otherwise herein, you shall not rent, lease, sublicense, sell, assign, loan, or otherwise transfer the Software. You shall not, and you shall not permit any third party, to reverse engineer, decompile, or disassemble the Software, except to the extent that applicable law expressly prohibits the foregoing restriction. You may not remove or destroy any product identification, copyright notices, or other proprietary markings or restrictions from the Software. All titles, trademarks, and copyright and restricted rights notices shall be reproduced on your back up copy of the Software. You may not modify or adapt the Software, merge the Software into another program or create derivative works based upon the Software.

**4. Disclaimer.** THE SOFTWARE IS DESIGNED TO ASSIST YOU IN TRANSFERRING MATERIAL OVER WHICH YOU HOLD THE COPYRIGHT OR WHICH HAVE OBTAINED PERMISSION TO OBTAIN AND TRANSFER FROM THE COPYRIGHT OWNER. UNLESS YOU OWN THE COPYRIGHT OR HAVE PERMISSION TO OBTAIN AND TRANSFER FROM THE COPYRIGHT OWNER, YOU MAY BE VIOLATING COPYRIGHT LAW AND BE SUBJECT TO PAYMENT OF DAMAGES AND OTHER REMEDIES. IF YOU ARE UNCERTAIN ABOUT YOUR RIGHTS, YOU SHOULD CONTACT YOUR LEGAL ADVISOR. YOU ASSUME FULL RESPONSIBILITY FOR THE LEGAL AND RESPONSIBLE USE OF THE SOFTWARE

**5. Open Source Software.** (a) This software may contain components that are subject to open-source terms, as stated in the documentation accompanying the Device. This Agreement does not apply to this software as such. (b) Your license rights under this Agreement do not include any right or license to use, distribute or create derivative works of the Software in any manner that would subject the Software to Open Source Terms. "Open Source Terms" means the terms of any license that directly or indirectly (1) create, or purport to create, obligations for ProDVX with respect to the Software and/or derivative works thereof; or (2) grant, or purport to grant, to any third party any rights or immunities under intellectual property or proprietary rights in the Software or derivative works thereof.

**6. Termination.** This Agreement shall be effective upon installation or first use of the Software and shall terminate (i) at the discretion of ProDVX, due to your failure to comply with any term of this Agreement; or (ii) upon destruction of all copies of the Software and related materials provided to you by ProDVX hereunder. ProDVX's rights and your obligations shall survive the termination of this Agreement.

**7. Upgrades.** ProDVX may, at its sole option, make upgrades to the Software available by general posting on a website or by any other means or methods. Such upgrades may be made available

pursuant to the terms of this Agreement or the release of such upgrades to you may be subject to your acceptance of another agreement.

**8. Support Services.** ProDVX is not obligated to provide technical or other support (“Support Services”) for the Software. If ProDVX does provide you with Support Services, these will be governed by separate terms to be agreed between you and ProDVX.

**9. Limited Software Warranty.** ProDVX provides the Software ‘as is’ and without any warranty except that the Software will perform substantially in accordance with the documentation accompanying the Software for a period of one year after your first download, installation or use of the Software, whichever occurs first. ProDVX’s entire liability and your exclusive remedy for breach of this warranty shall be, at ProDVX’s option, either (i) the refund of the price paid by you for the Software (if any); or (ii) the repair or replacement of the Software that does not meet the warranty set forth herein and that is returned to ProDVX with a copy of your receipt. This limited warranty shall be void if failure of the Software has resulted from any accident, abuse, misuse or wrongful application. Any replacement Software will be warranted for the remainder of the original warranty period or thirty (30) days, whichever is longer. This limited warranty shall not apply to you if the Software was provided to you free of charge on an evaluation only basis.

**10. NO OTHER WARRANTIES.** EXCEPT AS SET FORTH ABOVE, PRODVX AND ITS LICENSORS DO NOT WARRANT THAT THE SOFTWARE WILL OPERATE ERROR FREE OR UNINTERRUPTEDLY, OR WILL MEET YOUR REQUIREMENTS. YOU ASSUME ALL RESPONSIBILITIES FOR THE SELECTION OF THE SOFTWARE TO ACHIEVE YOUR INTENDED RESULTS, AND FOR THE INSTALLATION OF, USE OF, AND RESULTS OBTAINED FROM THE SOFTWARE. TO THE MAXIMUM EXTENT PERMITTED BY APPLICABLE LAW, PRODVX AND ITS LICENSORS DISCLAIM ALL WARRANTIES AND CONDITIONS, WHETHER EXPRESS OR IMPLIED, INCLUDING BUT NOT LIMITED TO THE IMPLIED WARRANTIES OF MERCHANTABILITY, FITNESS FOR A PARTICULAR PURPOSE, AND ACCURACY OR COMPLETENESS OF RESULTS WITH RESPECT TO THE SOFTWARE AND THE ACCOMPANYING MATERIALS. THERE IS NO WARRANTY AGAINST INFRINGEMENT. PRODVX DOES NOT WARRANT THAT YOU WILL BE ABLE TO DOWNLOAD, COPY, STORE, DISPLAY, TRANSFER, AND/OR PLAY SECURE CONTENT.

**11. LIMITATION OF LIABILITY.** UNDER NO CIRCUMSTANCES WILL PRODVX OR ITS LICENSORS BE LIABLE FOR ANY CONSEQUENTIAL, SPECIAL, INDIRECT, INCIDENTAL OR PUNITIVE DAMAGES WHATSOEVER, INCLUDING, WITHOUT LIMITATION, DAMAGES FOR LOSS OF PROFITS OR REVENUES, BUSINESS INTERRUPTION, LOSS OF BUSINESS INFORMATION, LOSS OF DATA, LOSS OF USE OR OTHER PECUNIARY LOSS, EVEN IF PRODVX OR ITS LICENSORS HAVE BEEN ADVISED OF THE POSSIBILITY OF SUCH DAMAGES. IN NO EVENT SHALL PRODVX’S OR ITS LICENSORS’ AGGREGATE LIABILITY FOR DAMAGES ARISING OUT OF THIS AGREEMENT EXCEED THE GREATER OF THE PRICE ACTUALLY PAID BY YOU FOR THE SOFTWARE OR FIVE POUNDS STERLING (5.00).

**12. Trademarks.** Some of the product and ProDVX names used in this Agreement, the Software, and the printed user documentation may constitute trademarks of the ProDVX, its licensors or other third parties. You are not authorized to use any such trademarks.

**13. Export Administration.** You agree that you will not directly or indirectly, export or re-export the Software to any country for which the United States Export Administration Act, or any similar United States law or regulation requires an export license or other U.S. Government approval, unless the appropriate export license or approval has first been obtained. By downloading or installing the Software you agree to abide by this Export provision.

**14. Governing law.** This Agreement is governed by the laws of the Netherlands, without reference to its conflict of laws principles. This Agreement shall not be governed by the United Nations Convention on Contracts for the International Sale of Goods, the application of which is expressly excluded. Any dispute between you and ProDVX regarding this Agreement shall be subject to the non-exclusive jurisdiction of the courts of the Netherlands. If for any reason a court of competent jurisdiction finds any provision, or portion thereof, to be unenforceable, the remainder of this Agreement shall continue in full force and effect.

**15. General.** This Agreement contains the entire agreement between you and ProDVX and supersedes any prior representation, undertaking or other communication or advertising with respect to the Software and user documentation. If any part of this Agreement is held invalid, the remainder of this Agreement will continue in full force and effect. This Agreement shall not prejudice the statutory rights of any party dealing as a consumer



2023© ProDVX Europe B.V.

DFU APPC-15XP R23 Version 0.2  
Specifications are subject to change without notice